

CODE NUMBER

3919033

DESCRIPTION

1.5 gpf, Rough Brass Finish, Top Spud, Single Flush, 12.75 L Dimension, Royal® Concealed Manual Specialty Urinal PWT Flushometer.

DETAILS

- Flush Volume: 1.5 gpf (5.7 Lpf)
- Finish: Rough Brass (RB)
- Valve: Diaphragm
- Valve Body Material: Semi-red Brass
- Fixture Type: Urinal
- Fixture Connection: Top Spud
- Rough-In Dimension: 13 ½" (343mm)
- Spud Coupling: ¾" (19mm)
- Supply Pipe: ¾" (19mm)
- L Dimension: 12 ¾" (324mm) (12-3/4-LDIM)

FEATURES

Quiet, Concealed, Diaphragm Type, Rough Brass Urinal Flushometer for either

- PERMEX® Synthetic Rubber Diaphragm with Dual Filtered Fixed Bypass
- Vacuum Breaker
- Metal Non-Hold-Open Push Button
- Elbow Flush Connection and Coupling for ¾" NPT Back Inlet (for connection in the pipe chase — flush connection through the wall not provided by Sloan)
- ¾" I.P.S. Wheel Handle Bak-Chek® Angle Stop
- Diaphragm, Stop Seat and Vacuum Breaker to be molded from PERMEX® rubber compound for Chloramine resistance



COMPLIANCES & CERTIFICATIONS



(cUPC Certified, BAA Compliant)

RECOMMENDED SPECIFICATION

Valve Body, Cover, Tailpiece and Control Stop shall be in conformance with ASTM Alloy Classification for Semi- Red Brass. Valve shall be in compliance with the applicable sections of ASSE 1037 and ANSI/ASME 112.19.2.

VALVE OPERATING PRESSURE (FLOWING)

15–80 PSI (103–552 kPa). Specific fixtures may require greater minimum flowing pressure - consult manufacturer requirements.

DOWNLOADS

- [Concealed Flushometer Installation Instructions for Stainless Steel Fixtures](#)
- [Control Stop Repair and Maintenance Guide](#)
- [Flush Connections Flanges Repair and Maintenance Guide](#)
- [Tail Piece Repair and Maintenance Guide](#)
- [Royal Manual Diaphragm Flushometer Repair and Maintenance Guide](#)
- [Additional Downloads](#)

NOTES

All information contained within this document subject to change without notice.

Looking for other variations of the ROYAL 613 product? [View the general spec sheet with all options.](#)

[Find a compatible urinal](#) for this flushometer.

[Find a compatible water closet](#) for this flushometer.

Sloan 10500 Seymour Ave, Franklin Park, IL 60131

Phone: 800.982.5839 • Fax: 800.447.8329 • sloan.com

ROUGH-IN

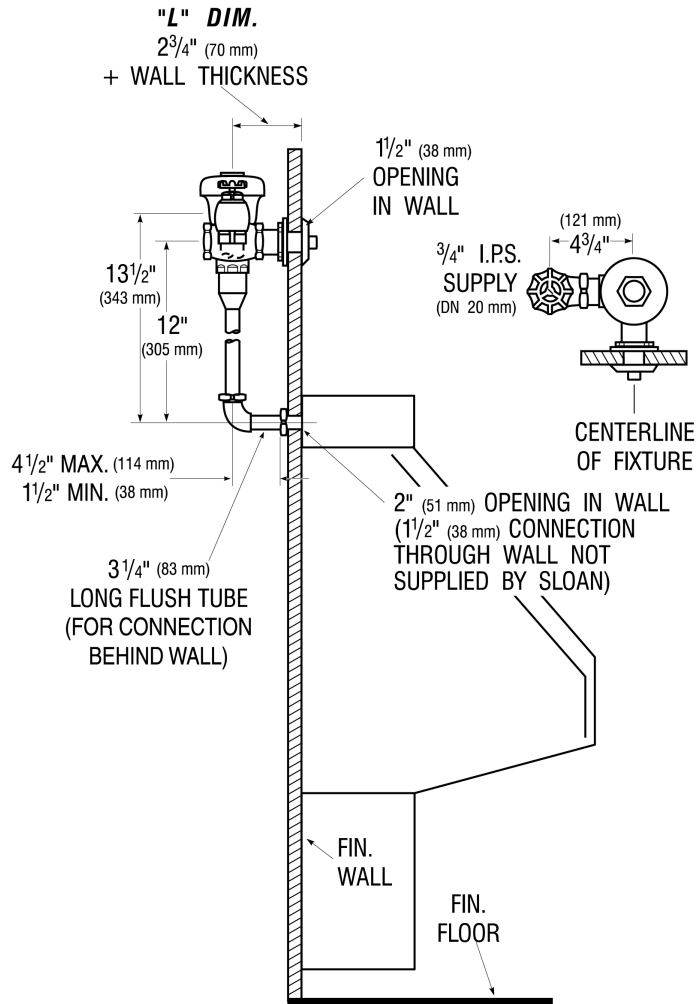

Sloan 10500 Seymour Ave, Franklin Park, IL 60131
Phone: 800.982.5839 • Fax: 800.447.8329 • sloan.com